

GRUNDIG

GUSR91DAB

DAB Radio With PLL FM Tuner

User Guide

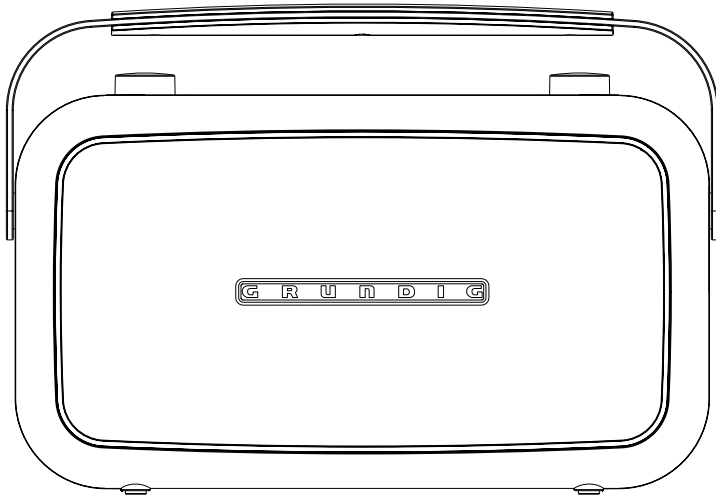

IMPORTANT: Please read all instructions carefully before use and keep for future use

Introduction

Thank you for choosing this Grundig DAB Radio with Touch Screen Control Panel.

Not only can it receive DAB radio stations, but you can also tune into FM radio stations or connect an auxiliary device to it. Throughout this User Guide the DAB Radio with Touch Screen Control Panel will be referred to as the DAB Radio

Safety is important

Use of any electrical equipment should be undertaken with care. Please read the safety section on page 17 and 18 before using your DAB Radio. This appliance is for household use only.

What's in the box?

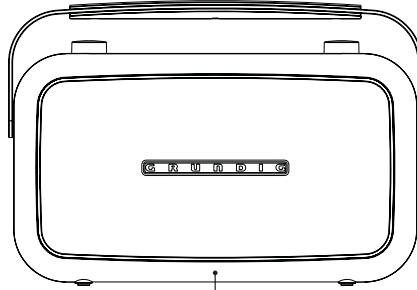

DAB Radio



This User Guide

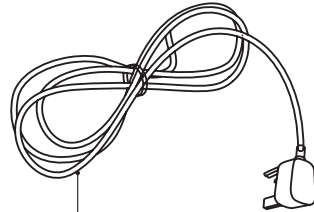

AC Power Cord

Contents

01 Your DAB Radio3	05 Specifications16
02 Get going4	06 Warnings17
03 Daily use5	07 Guarantee19
04 Trouble Shooting15	

01 Your DAB Radio

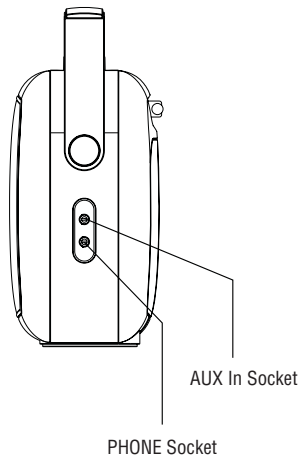
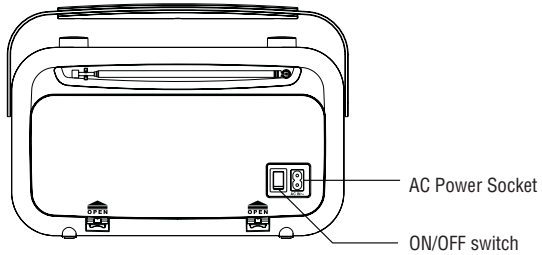
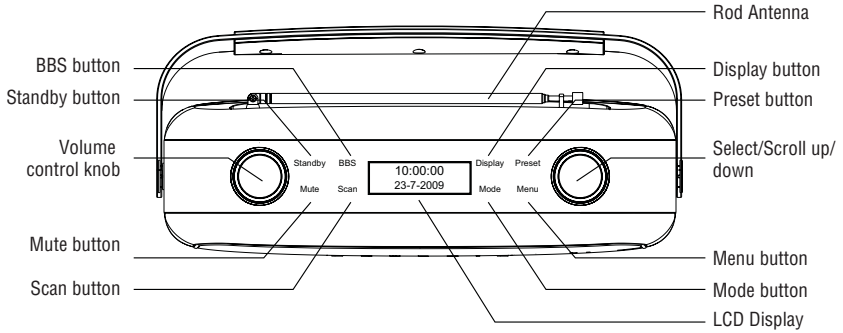

1

Connect the small end of the mains lead to the AC input socket on the rear of the unit. Connect the 3 pin plug to a suitable wall socket.

2

Turn the power switch on the rear of the unit to the ON position.

3

Using Headphones

A pair of headphones (not supplied) with a 3.5mm diameter stereo plug and 8-32 ohm impedance is required. Plug the headphones into the Headphone Socket on the side of the DAB Radio.

When headphones are connected, the sound to the speakers is automatically turned off.

4

Using the DAB Radio with Batteries

The DAB Radio can be powered by 6 "C" types Batteries. This allows the DAB Radio to be used outside or away from wall sockets.

To remove the Battery Compartment Cover, press the 2 retaining clips firmly and pull away from the DAB Radio.

Insert 6 "C" type batteries into the battery compartment, following the polarity diagram on the inside.

Replace the Battery Compartment Cover.

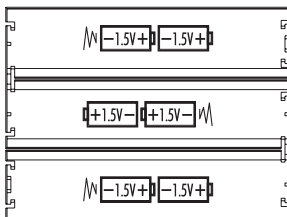

5

Using AUX IN

Connect an audio cable (not supplied) to the AUX IN socket on the side of the DAB Radio. Connect the other end to a suitable output socket on your auxiliary device.

Switching On

- ❶ To turn on the DAB Radio, ensure the power switch on the rear of the unit is set to the **ON** position.
- ❷ Press the **STANDBY** button on the touch panel.
- ❸ To turn the DAB Radio off press the **STANDBY** button again.

Adjusting the Volume

- ❶ To increase the volume, turn the volume control knob clockwise.
- ❷ To decrease the volume, turn the volume control knob anti-clockwise.
- ❸ You can also press the **MUTE** button to turn the sound off. To turn the sound back on, press the **MUTE** button again.

BBS function

The bass sounds can be enhanced by selecting the bass boost system.

- ❶ Press the **BBS** button to enhance the bass frequencies
- ❷ To turn off the bass boost system, press the **BBS** button again.

Listening to Radio

- ❶ Press the **STANDBY** button to turn the DAB Radio on.
- ❷ The following screen will be displayed. A bar graph indicates the progress of the search - the number of stations found increases as the scan progresses.

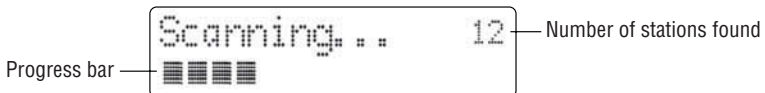

- ❸ When the scan is complete, the **DAB Radio** will then select the first available station - stations are listed in numerical then alphabetic order. The station list is retained in memory so the next time you switch the **DAB Radio** on, the station search does not take place. If there are no stations found, check that adequate **DAB** coverage exists in your area.

Changing DAB Stations

- 1 Rotate the **Scroll Up/Down** knob to scroll through the stations in the station list.
- 2 Press the **Scroll Up/Down** button to select a new station from the list.
Push the **SELECT** button to confirm. The radio will tune to the new station.

DON'T FORGET!

If no new station is selected the DAB Radio will display the currently playing station after 15 seconds.

From time to time new DAB stations may be added to the DAB station list.

If you wish to see if any new stations have been added, press the **SCAN** button to activate a full scan.

Storing DAB Presets

You can preset up to 10 DAB stations for easy access as follows:

- 1 Tune to the station you wish to preset (see Changing DAB Stations).
- 2 Press and hold the **PRESET** button, preset position 1 will show in the display.
- 3 Rotate the **SELECT/Scroll Up/Down** button to select the required preset memory position.
- 4 Push the **SELECT** button to save the current station into the specified preset location.

Selecting a Preset Station

- 1 Press the **PRESET** button briefly, preset position 1 will show in the display.
- 2 Rotate the **SELECT/Scroll Up/Down** button to select the desired preset.
- 3 Push the **SELECT** button to confirm.

DON'T FORGET!

If you select a preset location that has not been programmed with a station, "Preset empty" will be displayed.

The DAB Radio will return to the previously selected station after a few seconds.

Changing the DAB Station Information

It is possible to change the information displayed on the second line of the display when listening to a **DAB** station. There are seven types of information available as listed below with examples to the right.

- ❶ **Dynamic Label Segment (DLS)** This is scrolling text information supplied by the **DAB** station. It may comprise information on music titles or details of the programme and is provided by the broadcaster.
- ❷ **Signal Bar** Shows the transmission signal level.
- ❸ **Program Type (PTY)** This is a description of the type of programme provided by the **DAB** station and is provided by the broadcaster.
- ❹ **Multiplex Name** This will show the multiplex that is broadcasting the programme you are listening to.
- ❺ **Channel and Frequency** This displays the channel number and the transmission frequency.
- ❻ **Signal Error Rate** If the transmission signal contains errors the system can apply correction. The amount of signal correction can be displayed as a numerical value between 0 and 99. As the value increases, you will hear the signal degrade. To improve reception, try adjusting the position of the antenna. Please note a signal error rate of 30 or more will make the station un-listenable.
- ❼ **Signal Information** This shows the digital bit-rate and the signal mode.
- ❽ **Time** This shows the current time and is provided by the broadcaster so will always be accurate.
- ❾ **Date** This displays the date and is provided by the broadcaster.

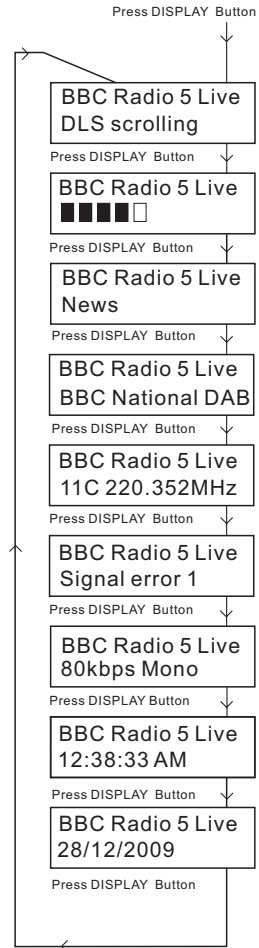

Using the MENU Control (DAB mode)

The **MENU** control allows you to change some of the system options on your DAB Radio. These options are arranged in a menu structure as shown below.

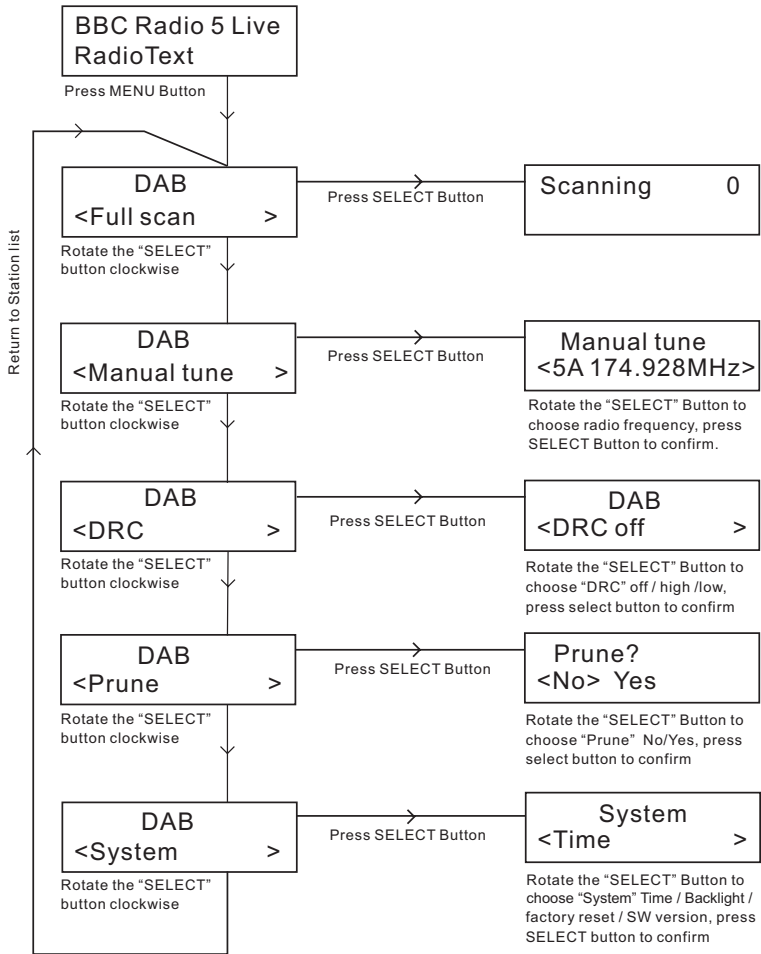

Using the Menu

Press the **MENU** button to enter the menu. Rotate the **SELECT** button to scroll through the options described below.

Full Scan

- 1 Press the **MENU** button to access the menu.
- 2 Rotate the **SELECT** button until “**Full scan**” is displayed.
Push the **SELECT** button to activate a full scan for DAB stations.

Manual Tune

It is possible to manually tune to a specific channel/frequency and add this to the station list. This function can be used to obtain the optimum reception for a specific Channel/frequency.

- 1 Press the **MENU** button to access the menu.
- 2 Rotate the **SELECT** button until “**Manual tune**” is displayed.
Push the **SELECT** button to select.
- 3 Rotate the **SELECT** button to select the desired channel/frequency.
- 4 Push the **SELECT** button, a rectangle will be displayed on the second line of the display.

The position of this rectangle indicates the signal strength (the further towards the right, the greater the signal strength)

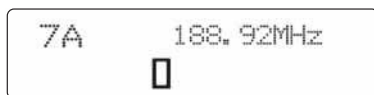

- 5 Adjust the position of the antenna to obtain the optimum signal strength.
- 6 Push the **SELECT** button to confirm.

Dynamic Range Control (DRC)

DRC adds or removes a degree of compression to compensate for the differences in the dynamic range between radio stations. For example, a station broadcasting popular music may have a high level of compression applied since the emphasis is on a constant high listening level. Where as a station broadcasting classical music will have little or no compression as the listener requires all of the highs and lows in the music to define the detail.

There are three levels of compression:

- **DRC off** = No compression applied
- **DRC high** = Maximum compression applied (this is the default)
- **DRC low** = Low compression applied

The best way to determine which of these settings suits you best is to experiment with them on a variety of source material.

- 1 Press the **MENU** button to access the menu.
- 2 Rotate the **SELECT** button until “**DRC**” is displayed.
- 3 Push the **SELECT** button to select.
- 4 Rotate the **SELECT** button to select between the three **DRC** values. The available options appear on line 2 of the display. When the required **DRC** value is displayed push the **SELECT** button to confirm.
- 5 You should be able to hear the difference in compression immediately.

Station Prune

The Station Prune function allows you to remove stations from the station list that are not active or cannot be received. These stations usually appear in the display with a "?".

- 1 Press the **MENU** button to access the menu.
- 2 Rotate the **SELECT** button until "Prune" is displayed.
- 3 Press the **SELECT** button to select.
- 4 Rotate the **SELECT** button to highlight either No or Yes
- 5 Press the **SELECT** button. If you have chosen to prune the station list, the unwanted stations will be deleted.

System Settings

To make adjustments to the settings on the DAB Radio:

- 1 Press the **MENU** button to access the menu.
- 2 Rotate the **SELECT** button until "System" is displayed.
- 3 Press the **SELECT** button. The following options: Time, Backlight, Factory Reset and Software (SW) version are available.

Time - Allows you to set the time and date manually or update automatically from the DAB or FM radio broadcast.

Backlight - Allows you to set the backlight time-out from 10, 15, 30 and 60 seconds, or constantly on.

DON'T FORGET!

When using battery power, the backlight time-out will be set to 10 seconds when the DAB Radio is switched to standby. You can touch any button on the radio to turn the backlight on for 10 seconds if you want to view the time.

If you are using mains power, the backlight will remain lit in standby mode.

Factory Reset - this will reset all preset values and begin a full scan for DAB stations.

Software Version - This displays information about the current software installed in the DAB Radio.

Using the FM Radio

❶ If the **DAB Radio** is in DAB mode, press the **MODE** button to select FM mode.

DON'T FORGET!

You may hear background noise as no station has been tuned in. The display will show the frequency of the FM station.

Automatic Tuning

❶ Press the **SCAN** button to automatically search for the next available station.

❷ If the reception is poor, try Manual Tuning (see Manual Tuning below) to fine-tune the station.

DON'T FORGET!

If the reception does not improve, try altering the position of the antenna. If the reception is still poor, scan again to determine whether a stronger signal exists for the desired frequency.

Manual Tuning

❶ Rotate the **SELECT** button to manually tune through the frequency band.

❷ The frequency will increase or decrease in steps of 0.05 MHz for each turn of the **SELECT** button.

Storing FM Presets

You can preset up to 10 FM stations. The procedure for storing and recalling FM presets is the same as described on page 6.

Changing the FM Station Information

It is possible to change the information that is displayed on the second line of the display when listening to a **FM** station. There are six types of information available as listed below with examples to the right.

- ❶ **Radio text** This is scrolling text information supplied by the **FM** station. It may comprise information on music titles or details of the programme and is provided by the broadcaster.
- ❷ **Program Type (PTY)** This is a description of the type of programme provided by the **FM** station and is provided by the broadcaster.
- ❸ **Station name** This is information of the station name / frequency of the current **FM** station.
- ❹ **Mono or Stereo** This indicates if the current station is broadcast in stereo or mono.
- ❺ **Time** This displays the current time and is provided by the broadcaster so will always be accurate.
- ❻ **Date** This displays the date and is provided by the broadcaster.

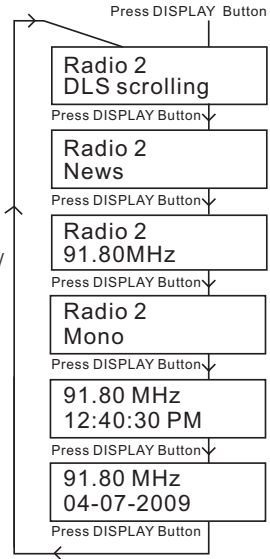

Using the MENU Control (FM mode)

The **MENU** control allows you to change some of the system options on your **DAB Radio**. These options are arranged in a menu structure as shown below.

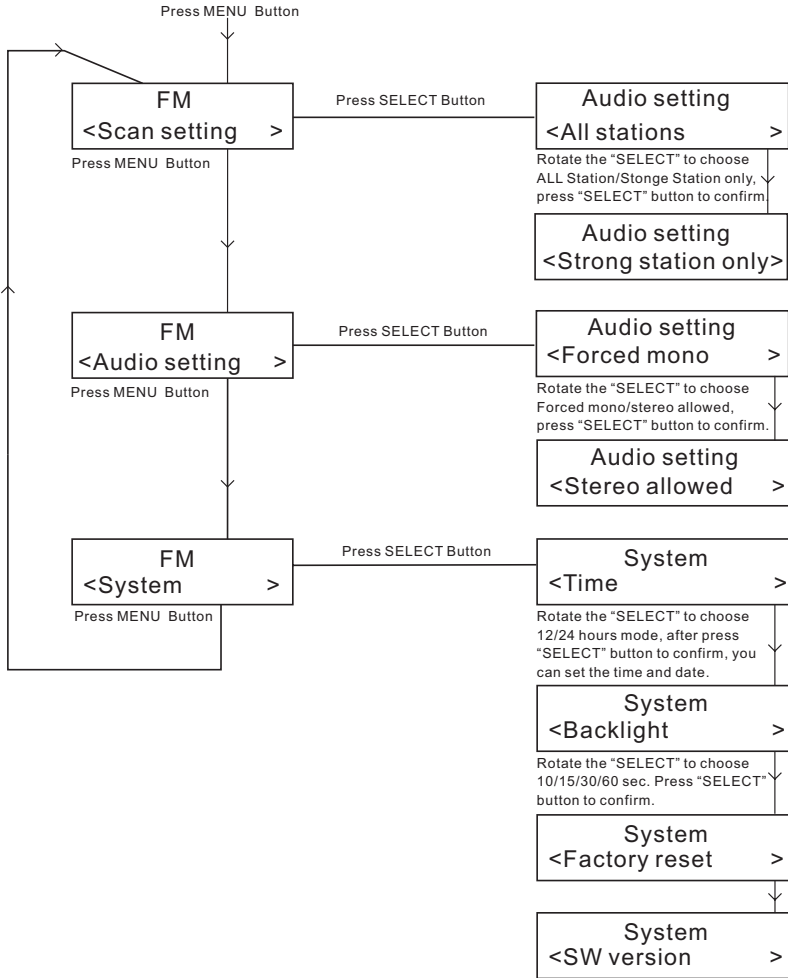

Using the Menu

Press the **MENU** button to enter the menu. Rotate the **SELECT** button to scroll through the options described below.

Scan

- 1 Press the **MENU** button to access the menu.
- 2 Rotate the **SELECT** button until “Scan setting” is displayed.
- 3 Push the **SELECT** button to select.
- 4 Rotate the **SELECT** button to select “**All stations**” or “**Strong stations**”.
- 5 Push the **SELECT** button to confirm.

DON'T FORGET!

All subsequent scans will be made according to the setting chosen.
A * will show next to the current scan setting.

Audio setting

- 1 Press the **MENU** button to access the menu.
- 2 Rotate the **SELECT** button until “**Audio setting**” is displayed.
- 3 Push the **SELECT** button to select.
- 4 Rotate the **SELECT** button to select “**Stereo or allowed**” or “**Forced mono**”.
- 5 Push the **SELECT** button to confirm.

DON'T FORGET!

Forced mono will present all FM stations in mono.

System Settings

To make adjustments to the settings in FM mode:

- 1 Press the **MENU** button to access the menu.
- 2 Rotate the **SELECT** button until “System” is displayed.
- 3 Press the **SELECT** button. The following options: Time, Backlight, Factory Reset and Software (SW) version are available.

Further information on these settings can be found in the DAB mode section of this User Guide.

PROBLEM	POSSIBLE CAUSE	REMEDY
No sound	Volume not adjusted. Headphones are connected. Mains lead is not correctly connected.	Adjust the Volume. Disconnect the headphones. Connect the mains lead properly.
The unit does react to operation of any button	Microprocessor locked up.	Turn off the unit, disconnect the mains plug, reconnect after a few seconds.
Poor radio reception	Weak radio signal Interference from other electrical items.	Ensure the telescopic antenna is fully extended. Adjust the position of the antenna. Move the radio away from sources of interference.

Need extra help?

Don't worry we are just at the other end of the phone. If you are experiencing problems using your new product, before returning it to the retailer, just call **0871 230 1777**.

Need a spare part?

In the unlikely event of you needing spare parts, please contact our spares department on: **0871 230 0790**

Model Number	GUSR91DAB
Power Supply	AC Input 230 V 50Hz or 6 X "C" (UM-2) batteries
Standby Power Consumption	2W
Max Power Consumption	13W
Max Power Output	1.2W
10% THD Power Output	1W
DAB section	Band III, 174 MHz to 240 MHz
FM section	87.5 MHz to 108 MHz

IMPORTANT: Due to continual revision and improvements to our products design, specifications are subject to change without notice.



WEEE

This appliance is labelled in accordance with European Directive 2002/96/EG concerning used electrical and electronic appliances (Waste Electrical and Electronic Equipment - WEEE).

The guideline determines the framework for the return and recycling of used appliances.

Sound levels

Your hearing is very important to you and to us, so please take care when using this DAB Radio. It is strongly recommended that you follow the listed guidelines in order to prevent possible damage or loss of hearing.

Establish a safe sound level

Over time your hearing will adapt to continuous loud sounds and will give the impression that the volume has in fact been reduced. What seems normal to you may in fact be harmful. To guard against this **before your hearing adapts**, set the volume to a low level.

Slowly increase the level until you can hear comfortably and clearly and without distortion. Damage to your hearing is accumulative and is irreversible. Any ringing or discomfort in the ears indicates that the volume is too loud.

Once you have established a comfortable listening level, **do not increase the sound level.**

General Safety

This DAB Radio has been designed and manufactured to meet European safety standards, but like any electrical equipment, care must be taken if you are to obtain the best results and safety is to be assured.

Do read these operating instructions before you attempt to use the DAB Radio.

Do ensure that all electrical connections (including the mains plug, extension leads and interconnections between pieces of equipment) are properly made in accordance with the manufacturer's instructions.

Switch off and remove the mains plug when making or changing any connections.

Do consult your dealer if you are ever in doubt about the installation, operation or safety of your DAB Radio.

Don't continue to operate the DAB Radio if you are ever in doubt about it working normally, or if it is damaged in any way. Switch it off, withdraw the plug from the mains and consult your dealer.

Don't remove any fixed covers as this may expose you to dangerous voltages.

Don't leave the DAB Radio switched On when it is unattended for long periods of time, unless it is specifically stated that it is designed for unattended operation or has a standby mode.

Make sure that other people in your household are conversant with the DAB Radio.

Don't obstruct the ventilation vents on the DAB Radio, for example with curtains or soft furnishings.

Overheating will cause damage and shorten the life of the product.

Don't allow electrical equipment to be exposed to rain or moisture.

Electrical Information

This DAB Radio is supplied with a mains lead fitted with a BS1363/A 13 amp plug. If it is not suitable for your supply sockets it must be removed and replaced with an appropriate plug. If the plug becomes damaged and/or needs to be replaced please follow the wiring instructions below.

The plug removed must be disposed of immediately. It must not be plugged into a supply socket as this will be an electrical hazard. If the fuse needs to be replaced it must be of the same rating and ASTA approved to BS1362. If the plug is changed, a fuse of the appropriate rating must be fitted in the plug, adapter or at the distribution board. If the fuse in a moulded plug is replaced, the fuse cover must be refitted before the appliance can be used.

Wiring Instructions

The supply cable will be either 2-core or 3-core. Follow the appropriate wiring instructions given below. In both cases ensure that the outer sheath of the cable is firmly held by the cable clamp.

2-Core Plug

WARNING! Do not connect either wire to the earth terminal.



This symbol indicates that this 2-core appliance is Class II and does not require an earth connection.

The wire coloured blue must be connected to the terminal marked with the letter N or coloured black.

The wire coloured brown must be connected to the terminal marked with the letter L or coloured brown.

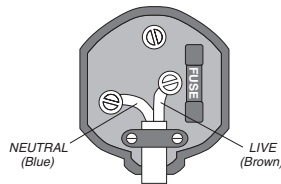

3-Core Plug

WARNING! This appliance must be earthed.

The wire coloured green and yellow must be connected to the terminal marked with the letter E, or by the earth symbol (⏏), or coloured green and yellow.

The wire coloured blue must be connected to the terminal marked with the letter N or coloured black.

The wire coloured brown must be connected to the terminal marked with the letter L or coloured brown.

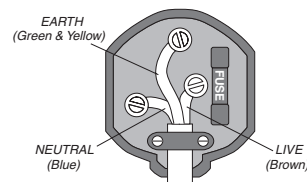

The DAB Radio is guaranteed for twelve months from the date of original purchase. If there are any defects due to faulty materials or workmanship, contact the Grundig Helpline. Have your receipt of purchase on hand.

The guarantee is subject to the following provisions:

- It is only valid within the boundaries of the country of purchase.
- The product must be correctly installed and operated in accordance with the instructions contained in this User Guide.
- The DAB Radio must be used solely for domestic purposes.
- The guarantee will be rendered invalid if the DAB Radio is re-sold or has been damaged by inexpert repair.
- The manufacturer disclaims any liability for incidental or consequential damages.
- The guarantee is in addition to, and does not diminish, your statutory or legal rights.

GRUNDIG

Helpline 0871 230 1777